

Sample Order / Cheat Sheet
N Window Hardware 1/2

QUOTE ORDER

NAME: _____
 ADDRESS: _____

 OFFICE PHONE: _____
 FAX PHONE: _____
 JOB PHONE: _____

PO# _____
 DELIVERY: _____
 ADDRESS: _____



HARDWARE WORK ORDER

Toll Free 888.788.2013 or 208.788.2013; Fax 208.788.2577

ORDER DATE: _____
 CONTACT: _____
 JOB NAME: _____

2002.12.04

| LINE NO. | FUNCTION | HANDLE | | ESCUTCHEON | | METAL | PATINA | HANDING OR LENGTH | BACKSET | DOOR THICKNESS | LOCK TYPE | DEAD BOLT TRIM | DESCRIPTION | LOCATION # | QTY. | PRICE QUOTED |
|----------|----------|----------|----------|------------|----------|-------|--------|-------------------|---------|----------------|-----------|----------------|-------------|------------|------|--------------|
| | | EXTERIOR | INTERIOR | EXTERIOR | INTERIOR | | | | | | | | | | | |
| 1 | WN | LW40 | | EW105 | | B | D | R | | 214 | | | | | 1 | 186.00 |
| 2 | AC | | | | | B | L | R | | | | | WC200 | | 1 | 165.00 |
| 3 | AC | | | | | W | L | | | | | | WC100 | | 1 | 160.00 |
| 4 | LC | LC300 | | | | W | D | R | | | | | LC305 | | 1 | 274.00 |
| 5 | AC | | | | | B | M | | | | | | SL100 | | 1 | 99.00 |

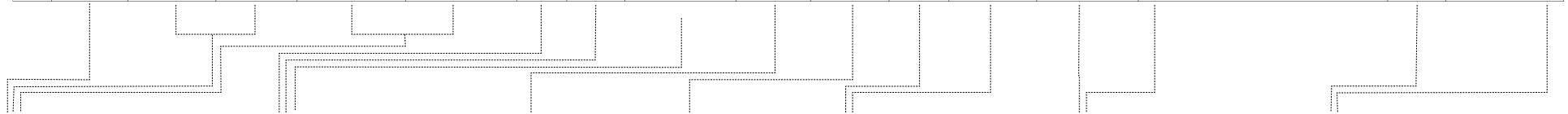

FUNCTION

AC = Accessory
 CA = Casement Adjuster
 LC = Casement Latch
 WN = Window Trim Set

HANDLE

For a list of Levers available for Window Hardware, see next page.
 For specifications, refer to Section A.

ESCUTCHEONS

For a list of Escutcheons available for Window Hardware, see next page.
 For configurations, specifications, and pricing, refer to content of this section.

METAL

B = Silicon Bronze
 W = White Bronze

PATINA

L = Light
 M = Medium
 D = Dark
 R = Rust
 BB = Brushed
 DL = Dark Lustre

HANDING / LENGTH

See Hinged Door Handing diagram, next page.

L = Left Hand
 R = Right Hand
 LR = Left Hand Reverse
 RR = Right Hand Reverse

Casement Adjuster lengths:
 10"
 12"
 14"
 20"

BACKSET

Not Applicable

DOOR THICKNESS

138 = 1 3/8"
 112 = 1 1/2"
 134 = 1 3/4"
 178 = 1 7/8"
 2 = 2"
 214 = 2 1/4"
 212 = 2 1/2"
 258 = 2 5/8"
 234 = 2 3/4"
 3 = 3"

Up-charge for sizes below.
 Call for pricing.
 314 = 3 1/4"
 312 = 3 1/2"
 4 = 4"
 N = No

LOCK TYPE

Not Applicable

DEAD BOLT TRIM

Not Applicable

DESCRIPTION

For a list of available descriptions, see next page.

LOCATION #

QTY

Number of each desired

PRICE

\$ List price each

HANDLES

LW05 = Mini Ellis Lever
 LW10 = Mini Euro Lever
 LW15 = Mini Legacy Lever
 LW20 = Mini French Lever
 LW33 = Mini Reed Lever
 LW37 = Mini Strap Lever
 LW40 = Mini Classic Lever
 LW50 = Mini Acanthus Lever
 LW60 = Mini Harrington Lever
 LW63 = Mini Olympus Lever
 LW65 = Mini Falcon Lever
 LW80 = Mini Monarch Lever
 LW85 = Mini Ribbon & Reed Lever
 L104 = Hook Lever
 T300 = T Handle
 LC300 = Casement Latch Lever

ESCUTCHEONS

Rectangular

EW101 = 1 1/4" x 3" Rect (WE)
 EW103 = 1 3/8" x 4 1/2" Rect (WE)
 EW105 = 1 1/2" x 3" Rect (WE)
 EW108 = 1 1/2" x 4 1/2" Rect (WE)

Stepped

EW308 = 1 1/2" x 4 1/2" Stepped (WE)

Metro

EW225 = 1 1/4" x 4 1/2" Metro (WE)
 EW202 = 1 1/2" x 4 1/2" Metro (WE)

Curved

EW507 = 1 1/4" x 4 1/2" Curved (WE)
 EW501 = 1 3/8" x 4 1/2" Curved (WE)
 EW508 = 1 1/2" x 4 1/2" Curved (WE)

Arched

EW720 = 1 3/16" x 3 3/4" Arched (WE)
 EW707 = 1 3/8" x 4 1/2" Arched (WE)
 EW705 = 1 1/2" x 3" Arched (WE)
 EW708 = 1 1/2" x 4 1/2" Arched (WE)

Ellis

EW005 = 1 1/2" x 4 1/2" Ellis (WE)

Convex

EW30500 = 1 1/2" x 3 3/4" Convex (WE)

Corbel Arched

EW30600 = 1 1/2" x 3 3/4" Corbel Arched (WE)

Corbel Rectangular

EW30700 = 1 1/2" x 3 3/4" Corbel Rect (WE)

Key

(WE) = Window Escutcheon

DESCRIPTION

LC303 = Mortise Strike
 LC305 = Universal Strike
 LC307 = Surface Strike
 SFP100 = Sash Lift
 SL100 = Sash Lock
 DHSL100 = Double-Hung Sash Lock
 DHSL200 = Double-Hung Sash Lock
 DHSL700 = Double-Hung Sash Lock
 ULL200 = Sash Lock (Pella)
 LC500 = Sash Lock (Loewen)
 LC510 = Sash Lock (Truth)
 LC600 = Sash Lock (Truth)
 LC730 = Sash Lock (Sierra Pacific)
 LC710 = Tilt Lock (Sierra Pacific)
 WC100 = Truth Window Crank & Cover
 WC140 = Marvin Window Crank & Cover
 WC141 = Marvin Window Crank & Cover
 WC160 = Truth Window Crank & Cover
 WC200 = Pella Window Crank & Cover
 WC400 = Marvin Window Crank & Cover
 WC450 = Truth Window Crank & Cover
 WL10 = Sash Lock (Marvin)
 WL180 = Sash Lock (Marvin)
 WL210 = Sash Lock (Marvin)
 WL211 = Sash Lock (Marvin Dummy)
 WD10 = Sash Lock (Marvin)
 WD130 = Sash Lock (Marvin)
 WSL10 = Sash Lift (Marvin)
 WSL20 = Sash Lift (Marvin)
 WSL40 = Sash Lift (Marvin)

- Price includes your choice of any lever.
- Combinations are shown with L104 Hook Lever for illustrations only. Refer to Section A for desired lever.
- Specify metal, patina, sash thickness, handing, screws, spindle length, and type of window designed for.
- Supplied with M5 x .8 x 40 mm screws and 7 mm spindle unless otherwise specified.
- Levers index at 3, 6, 9, and 12 o'clock positions.

Window Trim Sets

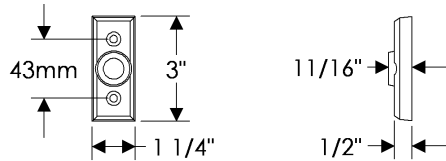

EW101 Rectangular Window Escutcheon
1 1/4" x 3" \$ 314.00

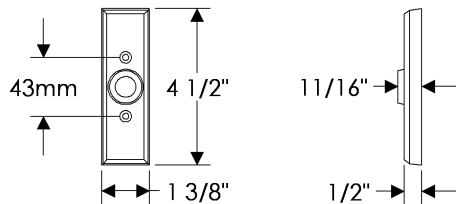

EW103 Rectangular Window Escutcheon
1 3/8" x 4 1/2" \$ 314.00

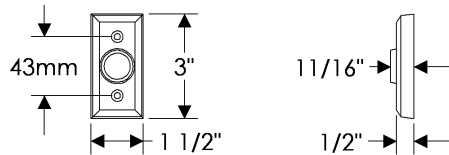

EW105 Rectangular Window Escutcheon
1 1/2" x 3" \$ 186.00

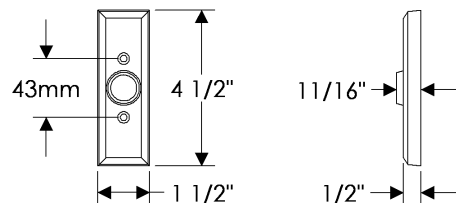

EW108 Rectangular Window Escutcheon
1 1/2" x 4 1/2" \$ 196.00

- Price includes your choice of any lever.
- Combinations are shown with L104 Hook Lever for illustrations only. Refer to Section A for desired lever.
- Specify metal, patina, sash thickness, handing, screws, spindle length, and type of window designed for.
- Supplied with M5 x .8 x 40 mm screws and 7 mm spindle unless otherwise specified.
- Levers index at 3, 6, 9, and 12 o'clock positions.

Window Trim Sets

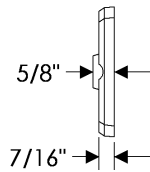
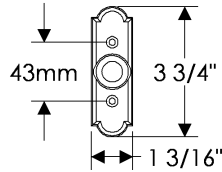

EW720 Arched Window Escutcheon
1 3/16" x 3 3/4" \$ 314.00

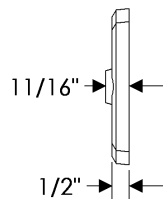
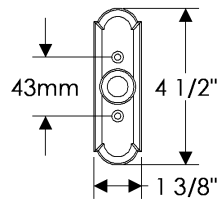

EW707 Arched Window Escutcheon
1 3/8" x 4 1/2" \$ 314.00

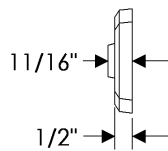
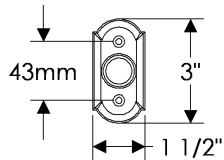

EW705 Arched Window Escutcheon
1 1/2" x 3" \$ 186.00

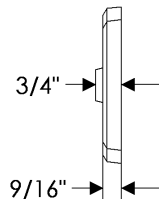
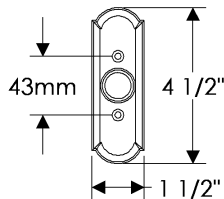

EW708 Arched Window Escutcheon
1 1/2" x 4 1/2" \$ 196.00

- Price includes your choice of any lever.
- Combinations are shown with L104 Hook Lever for illustrations only. Refer to Section A for desired lever.
- Specify metal, patina, sash thickness, handing, screws, spindle length, and type of window designed for.
- Supplied with M5 x .8 x 40 mm screws and 7 mm spindle unless otherwise specified.
- Levers index at 3, 6, 9, and 12 o'clock positions.

Window Trim Sets

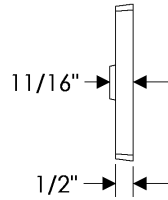
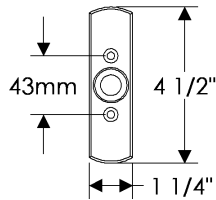

EW507 Curved Window Escutcheon
 1 1/4" x 4 1/2" \$ 314.00

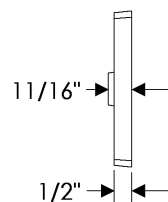
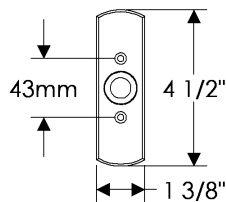

EW501 Curved Window Escutcheon
 1 3/8" x 4 1/2" \$ 314.00

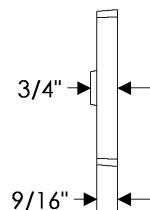
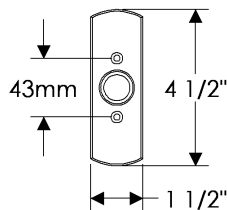

EW508 Curved Window Escutcheon
 1 1/2" x 4 1/2" \$ 196.00

- Price includes your choice of any lever.
- Combinations are shown with L104 Hook Lever for illustrations only. Refer to Section A for desired lever.
- Specify metal, patina, sash thickness, handing, screws, spindle length, and type of window designed for.
- Supplied with M5 x .8 x 40 mm screws and 7 mm spindle unless otherwise specified.
- Levers index at 3, 6, 9, and 12 o'clock positions.

Window Trim Sets

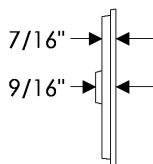
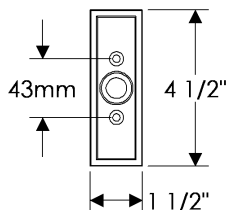

EW308 Stepped Window Escutcheon
 1 1/2" x 4 1/2" \$ 314.00

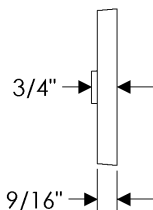
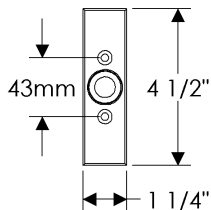

EW225 Metro Window Escutcheon
 1 1/4" x 4 1/2" \$ 314.00

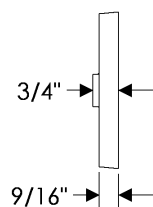
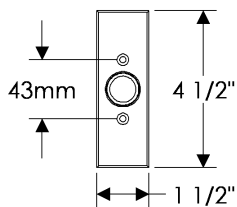

EW202 Metro Window Escutcheon
 1 1/2" x 4 1/2" \$ 196.00

- Price includes your choice of any lever.
- Combination is shown with LW05 Mini Ellis Lever for illustrations only. Refer to Section A for desired lever.
- Specify metal, patina, sash thickness, handing, screws, spindle length, and type of window designed for.
- Supplied with M5 x .8 x 40 mm screws and 7 mm spindle unless otherwise specified.
- Levers index at 3, 6, 9, and 12 o'clock positions.

Window Trim Sets

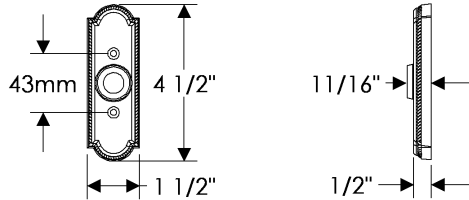

EW005 Ellis Window Escutcheon
 1 1/2" x 4 1/2" \$ 340.00

- Price includes your choice of any lever.
- Combination is shown with L104 Hook Lever for illustrations only. Refer to Section A for desired lever.
- Specify metal, patina, sash thickness, handing, screws, spindle length, and type of window designed for.
- Supplied with M5 x .8 x 40 mm screws and 7 mm spindle unless otherwise specified.
- Levers index at 3, 6, 9, and 12 o'clock positions.

Window Trim Sets

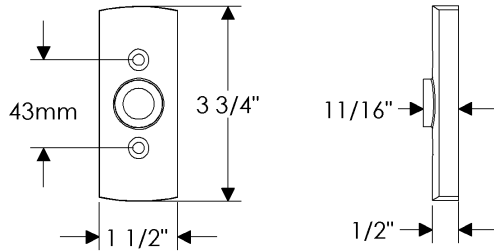

EW30500 Convex Window Escutcheon
1 1/2" x 3 3/4" \$ 340.00

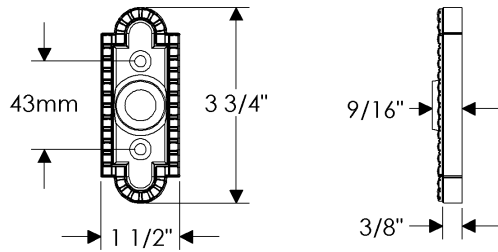

EW30600 Corbel Arched Window Escutcheon
1 1/2" x 3 3/4" \$ 340.00

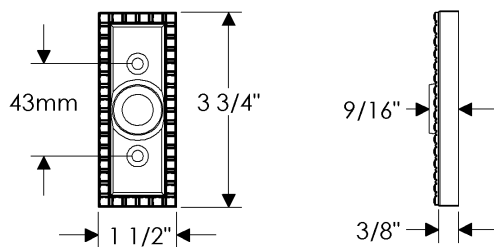

EW30700 Corbel Rectangular Window Escutcheon
1 1/2" x 3 3/4" \$ 340.00

- Specify metal, patina, sash thickness, handing, screws, spindle length, and type of window designed for.
- Supplied with #10-32 x 1" screws and 7 mm spindle unless otherwise specified.

Window Trim Sets

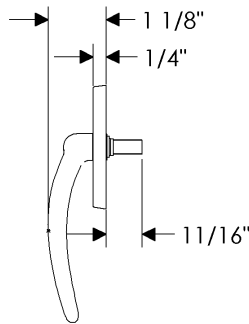
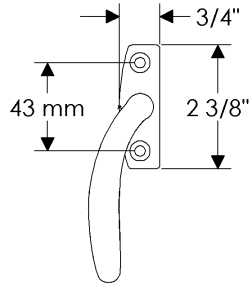

WL210 Sash Lock
 3/4" x 2 3/8" \$ 196.00

WL211 Sash Lock - Dummy
 3/4" x 2 3/8" \$ 196.00

- * Designed for Marvin push out
- * Left hand shown - handing not typical to standard specifications

- Specify metal and patina (and handing for the WC140 and WC141 series).

Window Cranks

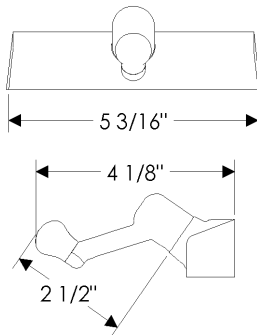
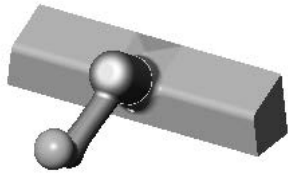

Casement Window Hardware*

WC100 Crank & Cover \$ 160.00

- * Designed for Truth Entry Guard.
- * Can be modified for compatibility with Ashland Mechanisms. Call for pricing.

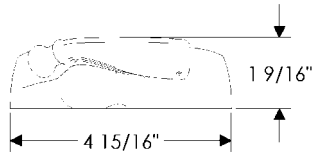

Casement Window Hardware*

WC140 Crank & Cover \$ 246.00

- * Designed for Marvin Ultimate Case Master
- * For handing examples, see image below.

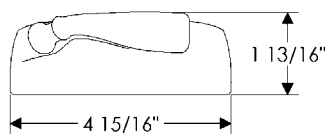
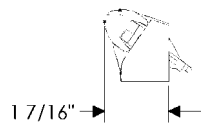

Casement Window Hardware*

WC141 Crank & Cover \$ 246.00

- * Designed for Marvin Ultimate Replacement Case Master
- * For handing examples, see image below.

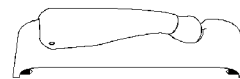
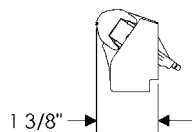

LEFT HAND COVER (L)

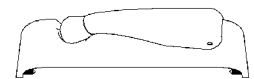

RIGHT HAND COVER (R)

- Specify metal, patina, and handing.

Window Cranks

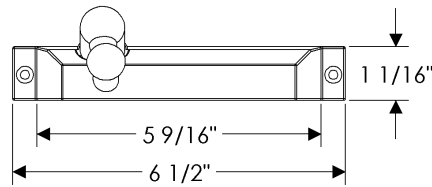
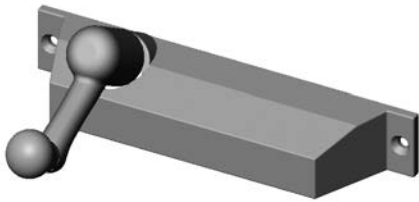

Casement Window Hardware*

WC160 Crank & Cover \$ 165.00

* Specify Truth Encore or Truth Maxim

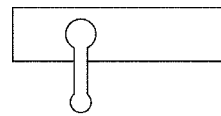

LEFT HAND WINDOW (L)

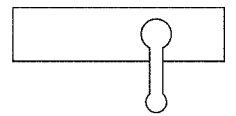

RIGHT HAND WINDOW (R)

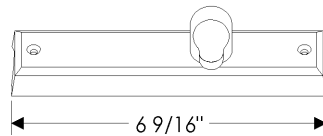
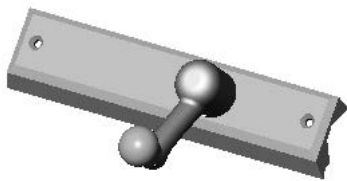
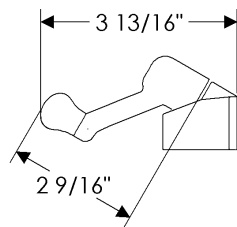

Casement Window Hardware*

WC200 Crank & Cover \$ 165.00

* Designed for Pella Architect and Designer Series models.

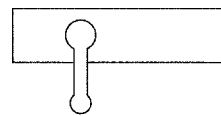
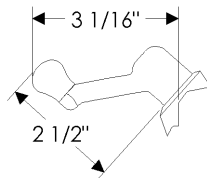

LEFT HAND WINDOW (L)

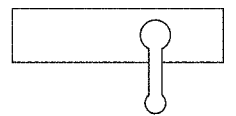

RIGHT HAND WINDOW (R)

- Specify metal, patina, and handing.

Window Cranks

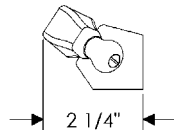
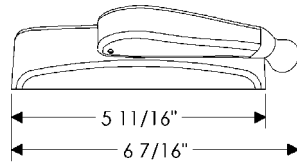

Casement Window Hardware*

WC400 Crank & Cover \$ 246.00

- * Designed for Truth Entry Guard.
- * Can be modified for compatibility with Ashland Mechanisms. Call for pricing.

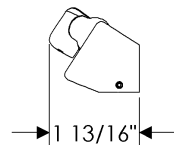
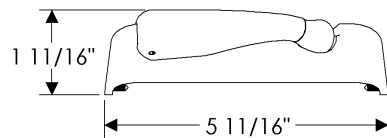
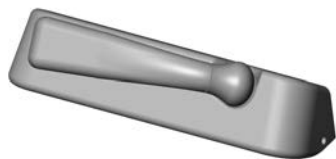

Casement Window Hardware*

WC450 Crank & Cover \$ 246.00

- * Designed for Truth Encore.
- * For most situations a left hand cover will work with a left hand window. Narrow windows may be an exception. Verify cover handing with images below.
- * For handing examples, see image below.

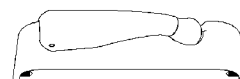

LEFT HAND COVER (L)

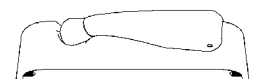

RIGHT HAND COVER (R)

- Specify metal, patina, and handing.

Casement Latches

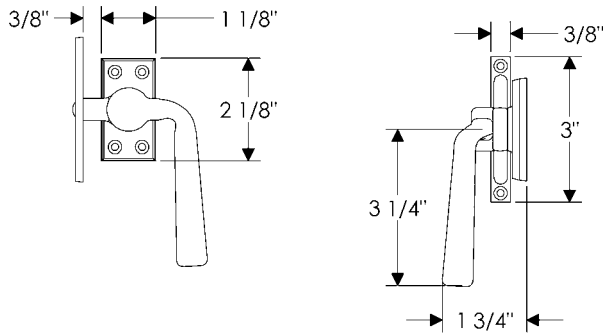

LC300 Casement Latch
with **LC303 Mortise Strike** \$ 262.00

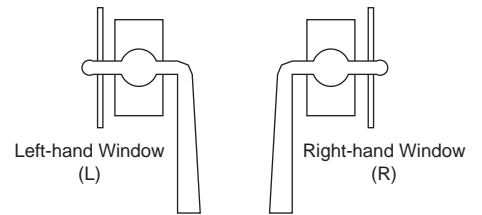

- Optional strike: **LC307**

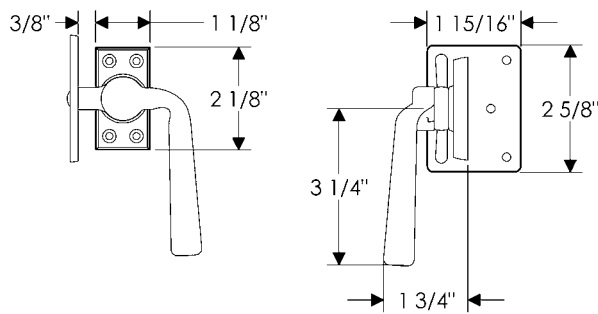
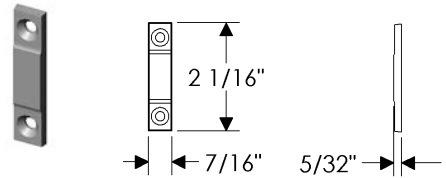

LC300 Casement Latch
with **LC305 Universal Strike** \$ 274.00

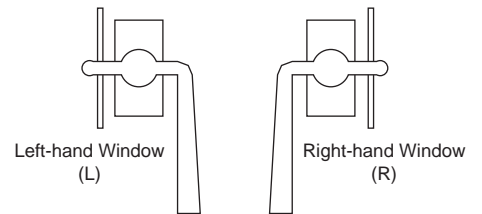

- Optional strike: **LC307**

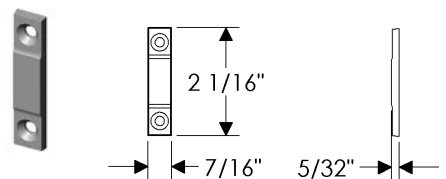

- Specify metal and patina (and handing for the ULL200 Sash Lock).

Sash Lifts

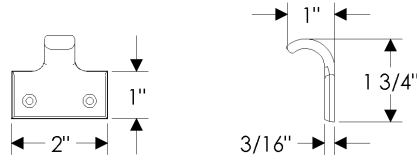

SFP100 Sash Lift \$ 42.00

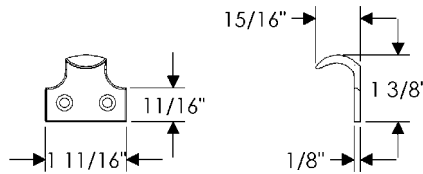

WSL20 Sash Lift \$ 39.00

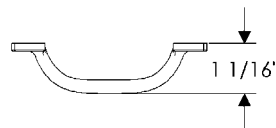
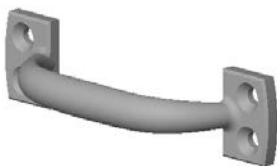

WSL10 Double-Hung Sash Lift \$ 50.00

* Compatible with Marvin Ultimate double hung.

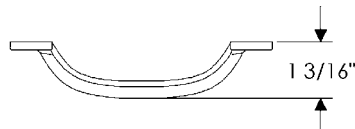
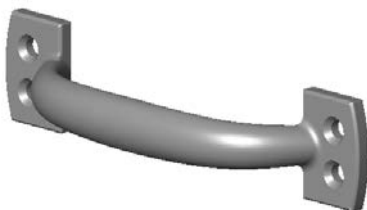
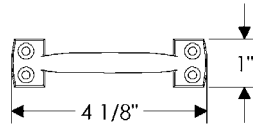

WSL40 Double-Hung Sash Lift \$ 85.00

* Compatible with Marvin Ultimate double hung magnum.

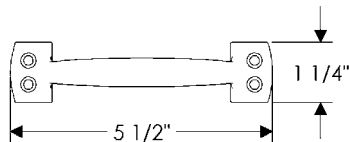

- Specify metal and patina (and handing for the ULL200 Sash Lock).

Sash Locks

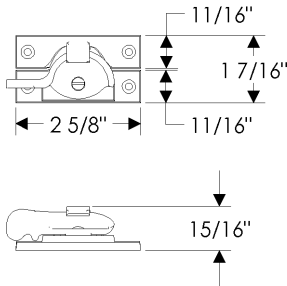

SL100 Sash Lock \$ 99.00

- Optional strike: **SLK105**

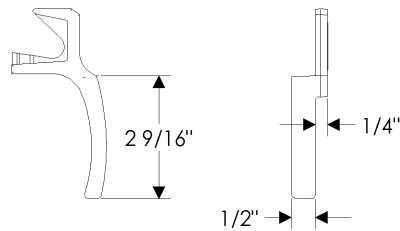
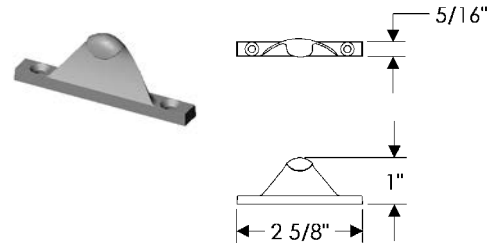

ULL200 Sash Lock* \$ 49.00

- * Designed for Pella windows.
Call for compatibility.

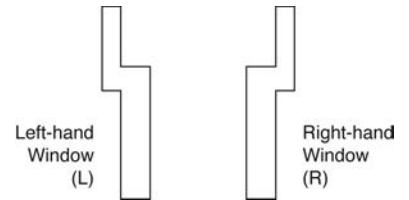

- Specify metal and patina.

Sash Locks

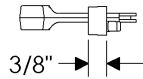
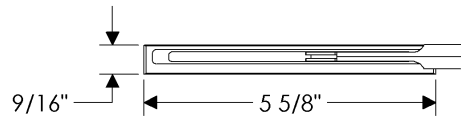

LC730 Sash Lock* \$ 278.00

- * Designed for Sierra Pacific windows.
- * Use in conjunction with WC450.

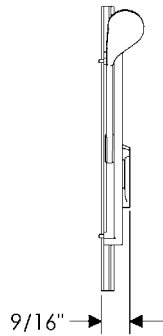
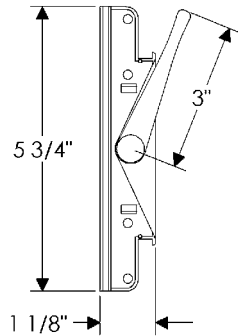

WL10 Sash Lock* \$ 210.00

- * Designed for Marvin Casemaster windows.
- Call for compatibility.

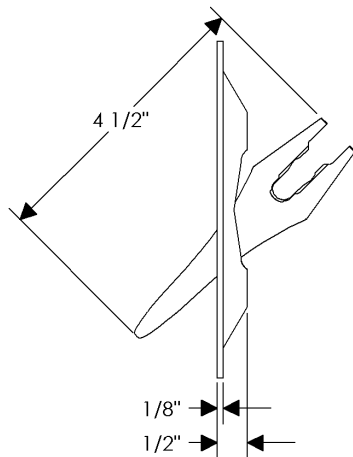
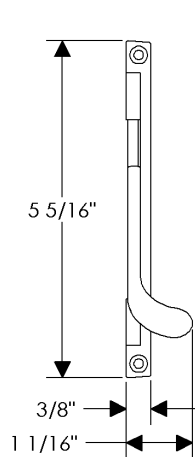

LC500 Sash Lock* \$ 278.00

- * Designed for Truth Mirage Concealed Multi-point Locking Systems.

- Specify metal and patina.

Sash Locks

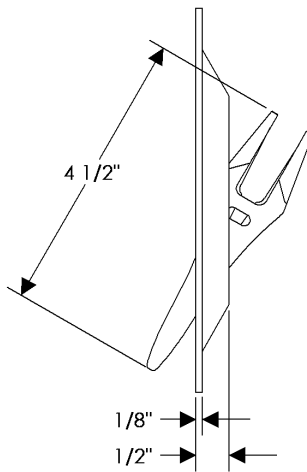
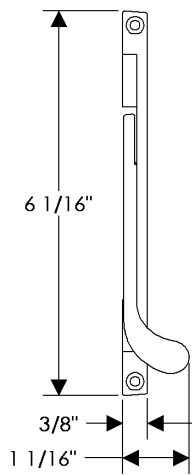

LC510 Sash Lock* \$ 278.00

* Designed for Ashland Multi-point Casement Locks.

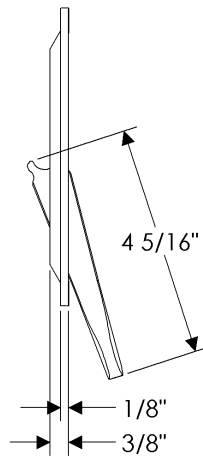
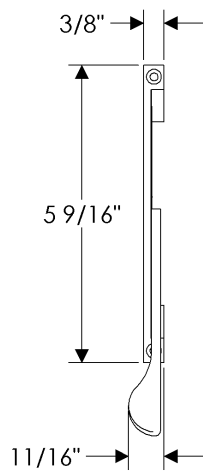

LC600 Sash Lock* \$ 278.00

* Designed for Truth Encore Multi-point Casement Locks.

* Field modifications required, call for specifications.

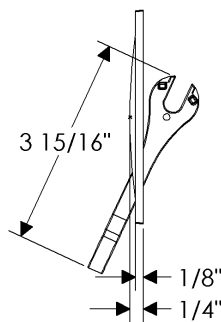
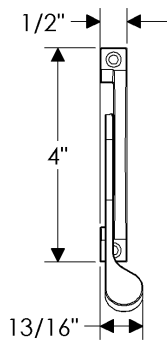

WL180 Sash Lock* \$ 278.00

* Designed for Marvin Ultimate Casemaster.

- Specify metal and patina.

Double-Hung Sash Lock

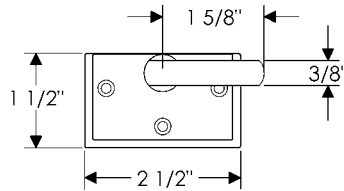
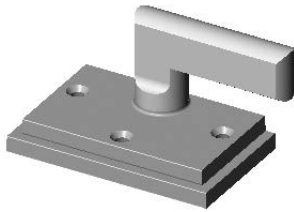

DHSL100 Double-Hung Sash Lock . . \$ 132.00

- Compatible with Pella Model 2 Architect series windows
- Includes strike (not pictured)

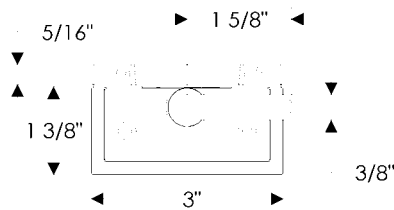
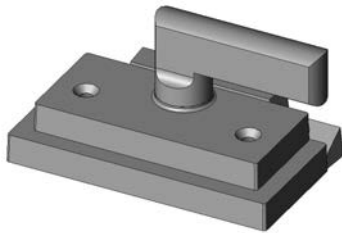
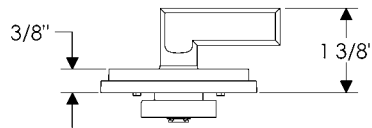

DHSL200 Double-Hung Sash Lock . . \$ 181.00

- Compatible with Pella Model 3 Architect series windows
- Includes bronze strike



- Specify metal and patina.

Double-Hung Sash Lock

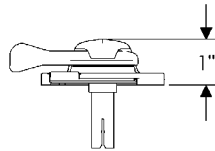
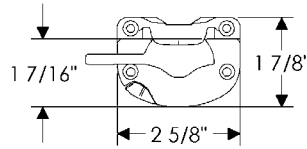

WD10 Double-Hung Sash Lock \$ 229.00

- Compatible with Marvin Ultimate double hung

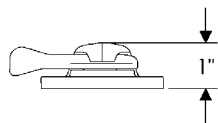
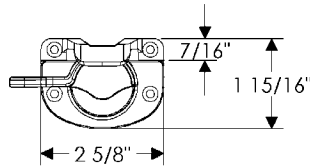

WD130 Double-Hung Sash Lock \$ 214.00

- Compatible with Marvin Ultimate double hung magnum

- Specify metal and patina.

Double-Hung Sash Lock

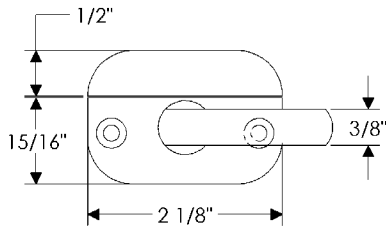

DHSL700 Double-Hung Sash Lock . . \$ 181.00

- Designed for Sierra Pacific
- Includes bronze strike
- Used in conjunction with LC710 Tilt Lock

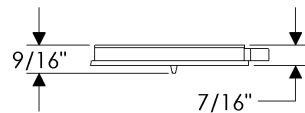
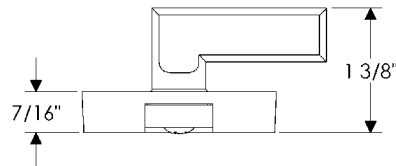

LC710 Tilt Lock \$ 171.00

- Designed for Sierra Pacific
- Used in conjunction with DHSL700 Double Hung Sash Lock

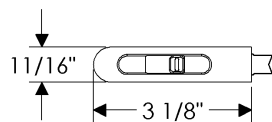

- Specify metal and patina.

Casement Adjusters

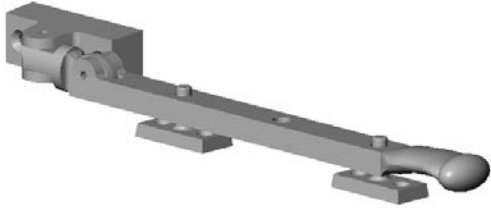

CA10 Casement Adjuster \$ 291.00

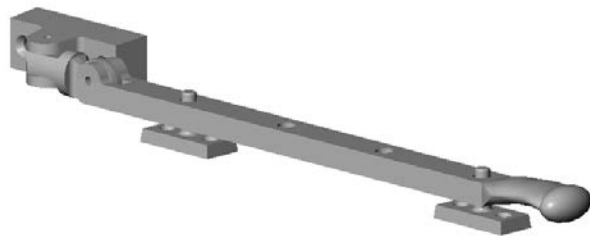
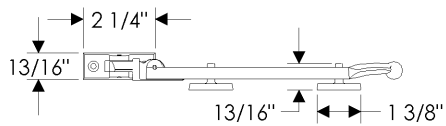
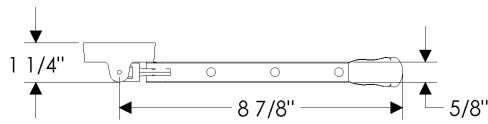

CA12 Casement Adjuster \$ 295.00

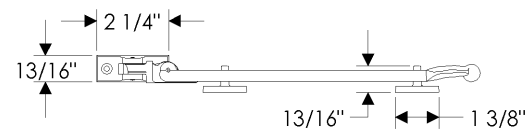
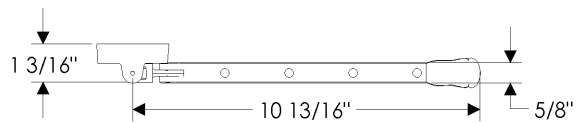

- Specify metal and patina.

Casement Adjusters

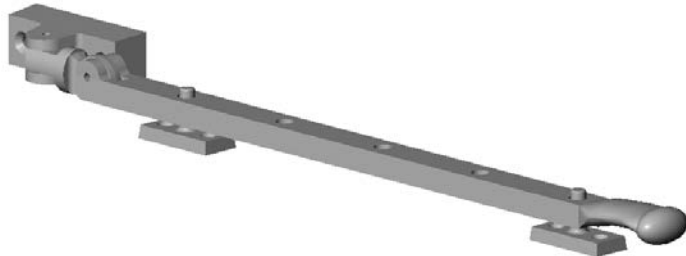

CA14 Casement Adjuster \$ 300.00

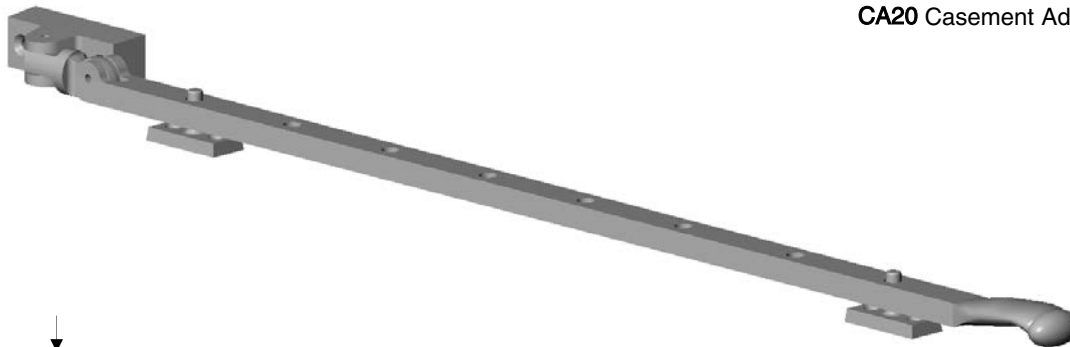
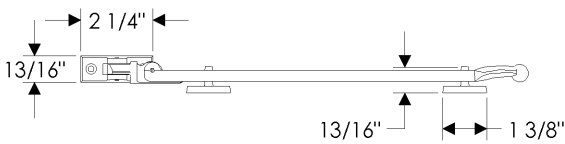
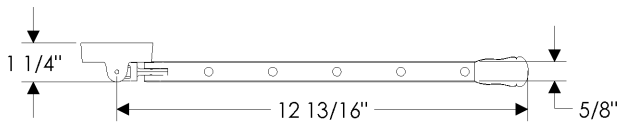

CA20 Casement Adjuster \$ 346.00

